



Model 60  
Model 100  
Model 130  
Model 150

Download **the Airfi App**  
to your smart device.

You get an easy-to-use weekly clock  
and many other functions.



[www.airfi.fi/app](http://www.airfi.fi/app)





# Table of contents

<b>Warnings and cautions</b>	<b>5</b>
<b>General information</b>	<b>6</b>
General information in brief	6
Basic operation of the air handling unit	6
Controls	7
Fans	8
Heat recovery cell	8
Protective functions	8
<b>Installation</b>	<b>10</b>
Installation of ventilation ducts	10
Wall installation	10
Ceiling installation	11
Floor mounting set	12
Vapour barrier sealing plate	12
Condensate removal	12
Airfi water seal	12
Kitchen bypass	13
Electricity, control cables and controllers	13
Duct radiators	13
<b>Controllers</b>	<b>14</b>
Uno	14
Sento	14
Mille-Wire	14
Mille-Wifi	15
Airfi App	15
Airfi Cloud	15
Seven segment	15
Bus control	15
Exhaust hood controls	15
<b>Commissioning</b>	<b>16</b>
Air flow rates	16
Basic air flow control	16
<b>Maintenance</b>	<b>16</b>
Opening	16
Filters	17
Heat recovery cell	17
Fans	17
Cleaning the duct system	17
Condensation water	17
Airfi water seal	17
Other maintenance	17
<b>Technical specifications</b>	<b>18</b>
Dimensional drawings	19
Air flow	20
Potentiometric setup – Seven-segment	24
Other functions	26

**Read the instructions for use, installation and maintenance carefully before proceeding.**

You can also download the instructions from our website: [www.airfi.fi](http://www.airfi.fi). The document is intended for anyone who services, installs or uses Airfi Oy's air handling units.

We reserve the right to make changes.

# Warnings and cautions

## Installation

The installation of the air handling unit should only be carried out by an authorised person. Installation must be carried out with care and in accordance with the regulations and standards in force for installation, adjustment and commissioning.

## Electrical installation work

The unit must be disconnected from the mains when carrying out voltage tests, insulation resistance measurements or other operations on the mains which may cause damage to sensitive electronic equipment.

## Overvoltage protection

Airfi recommends a surge arrester for all Airfi air handling units. Electrical installations must be carried out by a professional and in accordance with local regulations.

## Opening the unit

Slide the Airfi cover strip to the side. The hatch is opened using the screws under the cover strip, either with a screwdriver or by hand (NB: special care must be taken when using a screwdriver). When carrying out maintenance work, always make sure that the unit is disconnected from the power supply. Unplug the unit or switch off the power using the switch inside the unit. NB: Switching the unit off from inside the unit will cut off the power supply to the circuit board. There is still voltage on the primary side of the service switch. After power has been switched off, the fans will continue to run for a while. Wait a few minutes before carrying out any maintenance. This ensures that the fans have stopped.

## Drying laundry

We recommend that you do not connect a tumble dryer or drying cabinet to the extract air of the unit.

## Condensation water and condensation

In freezing temperatures, the surface temperature of the unit can temporarily drop so low that moisture can condense on the surface of the unit in humid conditions. Take this into account with regard to fixtures near the unit. Check the condensate drain pipe regularly to ensure that condensation water can drain freely into the drain.

## Commissioning

The unit should only be put into operation after the dust-generating work on site has been completed. The duct connectors of the air handling unit must be kept covered during transport, installation and storage. This keeps the ducts and the air handling unit clean and allows the unit to be commissioned without the need for additional cleaning.



**NB:**

This device is intended for use by adults. Children and persons with physical, sensory or mental limitations should only use the device with assistance.

# General information

## General information in brief

<b>Enclosure</b>	The enclosure class of the unit is IP34 when the hatch is closed
<b>Fans</b>	Airfi air handling units are equipped with energy-efficient EC DC fans. The fans can be controlled steplessly.  <b>NB:</b> On Airfi units, if a fan fails, you can disconnect the electrical connections from the finger connectors located outside the protected electrical compartment.
<b>Filter sets</b>  Model 60-100-130: <b>Filter Set #1</b>  Model 150: <b>Filter Set #2</b>	<b>Supply</b> ISO Coarse, 90% + ISO ePM 1 55% filters (formerly G4+F7)  <b>Extract</b> ISO Coarse, 90% filters (formerly G4).  Remember to replace the filters regularly, at least every six months. Use original Airfi Oy filters. You can easily order filters from our web shop: <a href="http://www.airfi.fi/verkkokauppa">www.airfi.fi/verkkokauppa</a>
<b>Heat recovery cell</b>	Heat recovery with counter-current technology in aluminium construction. Does not transfer odours or moisture. Suitable for all applications.
<b>Condensation water tray</b>	The tilted inner floor improves the removal of condensation water from the inside of the unit.
<b>Buzzer alert</b>	Gives a beep through the air handling unit housing.

## Basic operation of the air handling unit

People are spending more and more time indoors, so it is important what kind of indoor air you breathe. Airfi air handling units and exhaust hoods make the indoor air quality of your property excellent. Airfi's continuous ventilation efficiently provides ventilation for your property all year round. High-quality ventilation provides healthy indoor air in an energy-efficient way, without compromising living comfort.

In densely built buildings, ventilation is even more important. Ventilation removes moisture from the building. Ventilation prevents the transfer of moisture into structures and thus the growth of mould and fungal spores. The heat from the extract air is recovered, increasing energy efficiency.

With mechanical ventilation, fresh outdoor air is brought into the building through the unit. The air handling unit is equipped with efficient **ISO Coarse, 90% + ISO ePM 1 55%** filters (former designation G4+F7), which filter the air coming from the outside to the inside. Remember to replace the filters regularly, at least every six months. On the extract air side, the heat exchanger is protected against dirt by **ISO Coarse, 90%** filters (formerly G4).

The air handling unit heats the filtered supply air before it is released into the room. The incoming outdoor air is heated primarily by the heat of the air leaving the heat exchanger. Fresh supply air at the right temperature improves living comfort. Set the supply air temperature slightly lower than the room temperature. This ensures fresh indoor air and the air coming in mixes more effectively with the air in the room. The air handling unit must always be on. It only needs to be switched off for maintenance. This will ensure that the property has adequate ventilation and good living comfort.

Airfi recommends setting the supply air temperature to +17°C. Too high a temperature setting will increase energy consumption and the clean air blown into the room will not mix as well with the room air compared to if the supply air temperature is 3–4 degrees lower. If low temperature air is to be blown into the room, the risk of condensation in the duct system must be taken into account. This is why the factory setting for the minimum supply air temperature is 15°C. Please note that the air handling unit does not cool the supply air.

**Tip!**

If the duct system has been carefully insulated against condensation, even lower temperature air can be blown into the room.

## Controls

<b>Speed #1</b>	<b>Long absence</b> You can set the air flow rate very low, for example, when you are away for a long period of time.
<b>Speed #2</b>	<b>Absence / Low load</b> You can set the air flow rate low and use this speed when your home is not under much load.
<b>Speed #3</b>	<b>At home / Normal load</b> It is recommended that the air flow rates in the relevant building regulations be set for this speed.
<b>Speed #4</b>	<b>Boost / High load</b> Used, for example, in a situation where the house has a slightly higher than normal load.
<b>Speed #5</b>	<b>Boost / Maximum load</b> Used, for example, in a situation where there is a large number of people in the house, during a party, etc.

## Fans

Airfi units use EC DC fans. Replacing a fan does not require a person with an electrical work licence. The control and supply connections for the fans are fitted with plugs that do not present a risk of electric shock. Misuse is also prevented. The Model60/Model100/Model130/Model150 units are equipped with pin plugs. When replacing a fan, switch off the power at the unit's service switch.

## Heat recovery cell

Airfi air handling units use counter-current heat recovery technology. In the heat exchanger, fresh air from the outside cannot mix with the air to be extracted. This prevents the transfer of odours and moisture to the air inside the building. The heat exchanger can be easily removed from the unit and, if necessary, washed with a mild soap solution and water (do not use a pressure washer). Make sure that the heat exchanger is dry after washing before putting it back in the unit.

Airfi units also have a "cool recovery" function, which works if the home has, for example, an air-source heat pump. The heat load of the home is not increased, but if necessary, for example, on a hot summer's day, the air entering the house is cooled by air extracted from the inside.

Airfi units also have an enhanced cooling function. The function must be activated by the user, after which the unit will operate independently at the set values. After activation, the unit monitors temperatures and boosts air volumes as needed depending on conditions. The fan speed during enhanced cooling can be limited so that, for example, at night the fan does not run at maximum power but at the maximum speed set by the user.

Airfi units also feature an advanced heat recovery bypass. The heat recovery cell can also be only partially bypassed, allowing this feature to be used, for example, in spring when the outdoor temperature rises during the day.

## Protective functions

<b>Fault reports / Buzzer</b>	<p>Airfi units are equipped with an alarm buzzer as standard. The buzzer will sound to signal an alarm. The buzzer alarm is only given for critical faults, for example, if a fan is broken or if an R model unit is installed in an L model duct system.</p> <p>The unit will continue to operate in a limited manner in the event of a fault and will return to normal operation once the fault has been rectified. You can search for a service centre in your area at <a href="http://www.airfi.fi">www.airfi.fi</a></p>
<b>Fan overheat protection</b>	<p>The fans have built-in overheat protection. If the overheat protection mechanism is tripped, the fan stops. The mechanism is automatically resettable, meaning that when the temperature drops, the fan will restart.</p>



<p><b>Airfi Frost Pro System – self-learning hoarfrost protection (AFPS)</b></p>	<p>AFPS technology is used to achieve A+ rated annual efficiency in the Model 60, 100, 130 and 150 air handling units manufactured by Airfi Oy. AFPS is standard in all air handling units manufactured by Airfi Oy. The new AFPS is a self-learning hoarfrost protection system which guarantees excellent performance during cold periods.</p> <p>Airfi Frost Pro System is a Finnish invention, where the heat exchanger is defrosted only when there is a need for it and the heat exchanger is guaranteed to work even in prolonged freezing weather.</p> <p>The energy used to defrost the heat exchanger is taken from the extract air. This way, the energy provided by the heating resistors is used in the apartment rather than, for example, heating the exhaust air with the front resistors.</p> <p>The defrosting function is used optimally, saving energy compared to older solutions. The self-learning capabilities make it possible to take the individual characteristics of the air handling unit into account, for example, how dirty the filters and heat recovery cell are.</p>
<p><b>Electric heaters</b></p>	<p>Airfi automation is equipped with automatic self-reversing overheat protection. If the temperature gets too high, the supply to the resistor is cut off.</p> <p>In addition, the unit is equipped with mechanical overheat protection. If the mechanical overheat protection mechanism is tripped, the unit's electric heater cannot be switched on until the overheat protection activation is acknowledged. When the mechanical overheat protection mechanism is tripped, the cause of the tripping should always be determined.</p>
<p><b>Fire risk alarm</b></p>	<p>The unit has a built-in fire risk alarm. The fans stop if the temperature of the extract air exceeds +70°C or the temperature of the supply air exceeds +50°C. The parameters are configurable. The fans start to run again when the temperature drops (factory setting) or after reset.</p> <p>This function can be disabled by setting the value to 0.</p> <p>NB: You can select the acknowledgement method from the Modbus. For example, in the event of a fire risk alarm, you can choose whether the fans should start automatically or whether a reset is required.</p>

# Installation

The air handling unit should be installed in a room with a temperature of at least +10°C and where condensation drainage is possible. The air handling unit should not be installed on the wall opposite the bedroom or living room wall. When installing, care must be taken to ensure that the electrical and control cables are placed in an easily accessible location. The unit can be mounted on either a ceiling or wall bracket. The enclosure class of the air handling unit is IP 34 with the hatch closed.

The air handling unit has an external terminal box where the actuator connections are made. Make sure that the service hatch is no more than 1.6 m away from the unit.

## Installation of ventilation ducts

The instructions are general in nature. Install duct insulation according to the site plans.

Ventilation ducts and components are installed according to the HVAC plans. The installation of ventilation ducts should be carried out by an authorised installer. Correct and planned insulation prevents heat loss, moisture condensation and fire spread in ventilation ducts. Even small defects in insulation reduce sound absorption and pose a risk of condensation and indirect damage. The weight of the duct system must not put a load on the unit. In order to avoid structure-borne noise, ducts must not be installed directly against structures. In renovation projects, the insulation of the existing duct system should always be checked and, if necessary, insulation should be applied.

### General guidelines on insulation

The supply air duct must always be carefully insulated between the unit's duct outlet and the silencer, so that the sound of the fan is not carried into the room. The supply air duct is insulated in a cold room.

- » The exhaust air duct is insulated according to country-specific requirements (e.g. fire rating).
- » In a warm indoor space, the outdoor air duct and the exhaust air duct are insulated and condensation insulation is also installed.
- » Extract and supply air ducts do not need to be insulated in warm indoor spaces (note the condensation insulation in cooling).

The ducting through the vapour barrier to the attic must be done carefully. Silencers are placed in the supply and extract air ducts as close as possible to the unit. Make sure that the duct outputs of the unit you are installing correspond to the ducting of the site.

**NB:**

Before installing the unit, make sure that the handedness of the unit matches the ducting of the site.

**NB:**

The supply air duct must be condensed if indoor air is cooled through ventilation.

## Wall installation

Accessory

It is not recommended to install the unit on a wall adjacent to the bedroom. Sound propagation can be prevented, for example, by using a ceiling mount bracket.

The unit is mounted on the wall using an optional wall mount bracket. If the wall structure consists of vertical bars and building boards, the fixing point must be reinforced with horizontal bars. This ensures that the wall can support the weight of the unit. Airfi also recommends that the wall is insulated with sound-absorbing material or equivalent to prevent sound transmission.

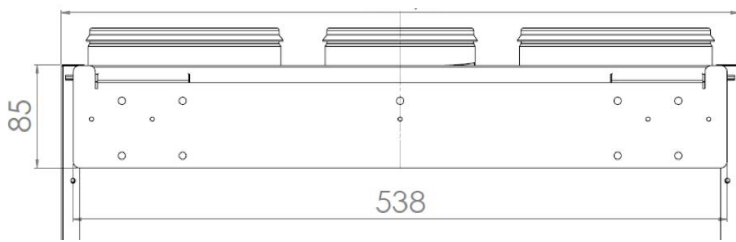

The "ears" of the wall mount bracket are flush with the top surface of the installed unit

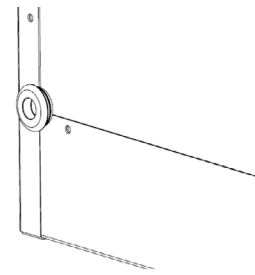

Air handling unit's bottom edge with vibration dampers

Vibration dampers are supplied with the wall mount bracket. Install the vibration dampers on both sides of the lower part of the rear of the unit. In wall mounting, the installation depth of the unit increases by 6 mm.

**Remember!**

For wall-mounted units, attach vibration dampers to the back of the unit.

## Ceiling installation

Accessory, Model 60, Model 100 and Model 130

The bottom surface of the ceiling mount bracket must be flush with the lower part of the finished ceiling surface. You can also find the installation instructions for the ceiling mount bracket on our website at [www.airfi.fi](http://www.airfi.fi).

The same ceiling mount bracket is suitable for both left-handed and right-handed units.

Model	Code	LVI number	Duct system size
Ceiling mount bracket 160-125-K: Model 60-100-130	40 000 013	7916031	Ø125mm
Ceiling mount bracket 160-160-K: Model 60-100-130	40000014	7916032	Ø160mm

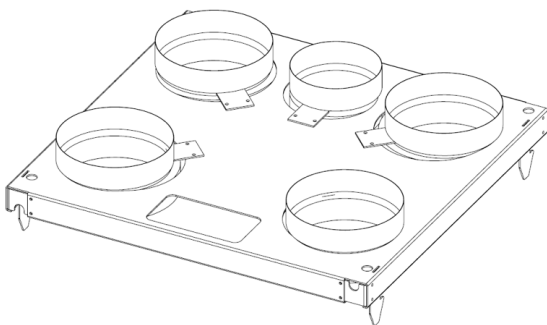

Full installation instructions for the ceiling mount bracket are supplied in the installation bag that comes with the bracket.

The air handling unit can be installed on the ceiling on a ceiling mount bracket. Take into account the height of the suspended ceiling, if any, when installing the ceiling mount bracket. The ceiling mount bracket is fixed to the ceiling anchors with M8 threaded rods. The end of the threaded rod must not exceed the level of the base of the ceiling mount bracket, so that it does not hit the body of the air handling unit. There must be at least four threaded rods per unit. M8 nuts are screwed to the threaded rods at the appropriate height so that the ceiling mount bracket remains suspended horizontally. You can use a spirit level to check this. The ceiling mount bracket is locked to the threaded rod with nuts.

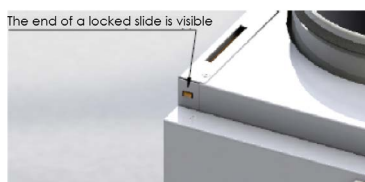

The unit is lifted onto the ceiling mount bracket so that all four locking mechanisms are in place. Check that the unit is still locked through the inspection hole, which clearly shows the locked hook mechanism (see photo).

## Floor mounting set

Accessory, Model 150

The Model 150 is recommended for mounting on a stand. Tilt the unit backwards and attach the levelling feet supplied in a separate package to the four corner points. There are holes for locating the stands. When lifting the unit, be careful not to damage the mounting feet. Adjust the unit directly using the adjusting screws on the feet. If possible, connect the condensate drain hose at the same time.

## Vapour barrier sealing plate

Accessory

The Airfi vapour barrier sealing plate facilitates the sealing of the ducts above the unit when the vapour barrier is penetrated. The duct outlets are located close together and the vapour barrier sealing plate makes the penetration point tight. Cut a hole smaller than 10–15 mm in the plate's cellular plastic. Place the plate on the ceiling at the desired point and fix it to the structure. Vapour barrier plastic is placed between the structure and the plate and taped tightly.

The same plate is suitable for both left-handed and right-handed units.

Model	Code	LVI number
Vapour barrier sealing plate: Model 60-100-130	40000015	7916033

## Condensate removal

Airfi units have a tilted inner floor, which allows the water at the bottom to drain out of the unit quickly. Condensation water is discharged from the unit through a condensation connection at the bottom of the unit. The connection has a 1/2" female thread.

Connect the optional Airfi water seal to the connector on the bottom of the unit according to the installation instructions provided with the water seal. To drain the water produced by the unit, you can also connect a drain hose or a drain pipe made by an installer to the drain connection, which allows condensation water to drain away from the bottom of the unit.

The inner diameter of the drain hose or pipe should be at least 12 mm. The drain hose or pipe must not be led directly into the sewer. The drain hose or pipe must not have two water seals or horizontal drains. The recommended minimum water seal height is 100 mm. Check that water can drain out of the bottom of the unit before starting it up. Pour water into the bottom of the unit and check that the water is draining out of the bottom of the unit.

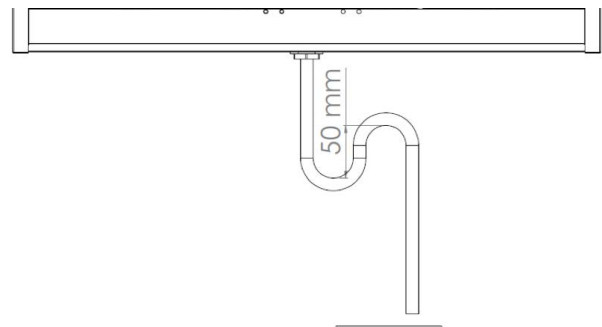

## Airfi water seal

The Airfi water seal is a silent ball valve water seal designed to remove condensation water from the unit. The water seal is suitable for use with all small air handling units. There should be about 14 cm of free space under the unit.

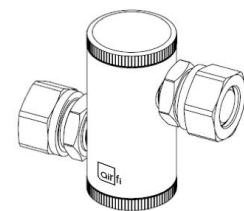

Model	Code	LVI number
Airfi water seal chrome-plated	40000053	7916072

## Kitchen bypass

The extract air from a kitchen exhaust hood is usually connected to an extract air duct. If you want a more efficient extract air flow through the exhaust hood than normal, a kitchen bypass duct can be used for Models 60, 100 and 130. The kitchen bypass is plugged and insulated when at the factory. To enable it, remove the insulation and open the air duct.

In general, the use of a kitchen bypass is recommended to ensure a high level of smoke removal when using flat exhaust hoods.

## Electricity, control cables and controllers

The unit is equipped with a grounded 1.6 m plug-in cable for power supply (clearance). The cable comes from above the unit. The plug acts as the main switch of the unit and should be placed in an easily accessible location.

Above the unit, there is a junction box where external connections are made (e.g. control hood/controllers). The unit also has an internet cable that connects it to the property's internet.









## Duct radiators

Cooling and heating duct radiators are available as an option for all Airfi models.

# Controllers

Individual instructions for controllers can be found in a separate document. Here is an overview of the controllers.

- » The air flow rates specified in the building regulations are recommended to be set at speed 3.
- » Air handling units and control hoods must always be fitted with an earthed plug.

 <b>At home / Away</b>	 <b>Service panel</b>	 <b>Controls multiple units</b>
 <b>Sauna function</b>	 <b>Boosting</b>	 <b>Wireless control</b>
 <b>Fireplace function</b>	 <b>Time programme</b>	 <b>Time and date</b>

## Uno

The Uno control panel has five speeds. The Uno control panel can be flush-mounted into an appliance box or mounted in a surface box. Appliance boxes are not supplied with the controller.



E.g. Nomak 2x2x0.5+0.5



## Sento



Sento – hard-wired controller with touch switches. Sento has five speeds. An appliance box must be installed behind the control panel. Appliance boxes are not supplied with the controller.



E.g. Nomak 2x2x0.5+0.5



## Mille-Wire



The Mille-Wire controller is hard-wired. This controller is also used as a service panel. Installation height 1.6 m. An appliance box must be installed behind the controller. Appliance boxes are not supplied with the controller. The product is supplied with a mounting bracket.

The Mille controller is an easy-to-use modern controller with a touch screen. If you have connected the Airfi air handling unit to the internet, you will receive up-to-date weather information and air handling unit alarms on the Mille control panel screen (the Mille-Wire controller is updated via USB).



E.g. Nomak 2x2x0.5+0.5



## Mille-Wifi



Mille – a Wifi connected control tablet (if the internet switch in the apartment does not have Wi-Fi functionality, choose the Airfi Wire controller), the Mille Wifi controller works wirelessly, so you will need a USB socket to connect the controller to the power supply (installation height 1.6 m).

The Mille controller is an easy-to-use modern controller with a touch screen. If you have connected your Airfi air handling unit to the internet, the Mille control panel displays up-to-date weather information, air handling unit updates and other information to make your life easier.



Ethernet, CAT5 or higher.

## Airfi App

An Airfi Oy supplied controller is not necessarily required to control an Airfi air handling unit. You can buy an app from the app store (Google Play Store or App Store [coming soon]) to control your air handling unit.

## Airfi Cloud

Coming soon

You can connect one or more units to our cloud service, where you can monitor the unit's activity (subject to a fee).

## Seven segment

Local control from inside the unit without separate controls. Air volume and voltage setting without a Mille controller or other manual controls is done using the Seven-segment display inside the unit. (see pages 24–25)

## Bus control

Airfi air handling units have Modbus RTU and TCP/IP bus interfaces as standard. Connection to the KNX bus requires a separate adapter (accessory: Airfi KNX adapter, product code: 40 000 098).

The Modbus master map is available as a separate document on our website.

The unit is equipped for control-command centre connections. The unit can be controlled from the control-command centre, e.g. by dual-speed operation or a 0–10 V voltage signal. The supply air temperature can be controlled by a 0–10 V voltage signal. The speed of the unit can be scanned to the control-command centre with a 0–10 V voltage signal.

## Exhaust hood controls

You can control the Airfi air handling unit with the control or booster hoods Pia, Suvi, Ida and Eva. Electronic hoods synchronise with the controls in real time.

# Commissioning

Air handling system settings during commissioning and maintenance can be made using the Mille-Wire service panel, the Mille Wifi control panel, the Airfi App or locally using the Seven-segment display (standard inside the air handling unit). The service code for the Mille panel is 12345. At the time of commissioning, at least the air flow rates must always be adjusted.

The unit's controller has five speeds. The air flow rates specified in the building regulations are recommended to be set at speed 3 = "at home" position.

## Air flow rates

If necessary, a sizing and selection tool can be found on the Airfi Oy website.

For unit-specific air flow curves, see page 20.

### Tip!

The set values should also be recorded on the label behind the unit cover strip.

The unit air flow rates are adjusted to the air flow rates specified by the ventilation designer. The automation also has the possibility to install restrictions on the maximum air flow rates (small apartments).

Remember to record the settings you have adjusted, so that, for example, if a circuit board breaks, the air flow rate does not need to be readjusted, but the values recorded can be set on the new board. It would be a good idea to record the set values of the Airfi units on the label behind the cover plate.

New apartments contain humidity due to construction, which is why we recommend keeping the ventilation at least at the air volumes specified in the building regulations. If ventilation is set to too low, moisture can condense on cool surfaces, such as windows.

## Basic air flow control

Before you start adjusting the air flow rates, open the unit and make sure there is no debris or objects that do not belong in the unit. Also check that the filters are clean.

# Maintenance

## Opening

At the top of the air handling unit is a plastic cover strip with the Airfi logo. Slide the strip to the right in the direction of the "open" text to release it and reveal the locking screws of the unit hatch. Open the locking screws and remove the unit hatch.

Before starting maintenance, disconnect the unit from the power supply by removing the plug from the socket.

Wait about two minutes before opening the front hatch of the air handling unit. The fans should have stopped and the potentially hot back-up heating resistor should have cooled down.

The unit can also be disconnected from the power supply by means of a service switch inside the unit. Turn the service switch to the 0 position before starting any maintenance work.



## Filters

Filter replacement every six months. The filter needs to be replaced more often if there is a lot of dust in the home or pollutants in the outdoor air. Open the door, remove the old filters from the unit and put the new filters in place. Always use original filters to ensure proper functioning. Filters are easy to order from [www.airfi.fi/verkkokauppa](http://www.airfi.fi/verkkokauppa)

Do not use the unit without filters.

### Filter sets and codes

Filter Set #1	Model 60-100-130	40000001
Filter Set #2	Model 150	40000002

## Heat recovery cell

The heat recovery cell must be cleaned every three years or more often if necessary. The cell comes off by pulling. Wash the cell with running water and a mild detergent (e.g. dishwashing liquid). We recommend cleaning the cell outside the heating season. Make sure the cell is dry before placing it in the unit.

## Fans

Clean and inspect every two years.

### Removal of fans:

- » Disconnect the unit from the mains
- » Open the lid
- » Remove the heat recovery cell
- » Remove the cell strips and the fan flashing
- » Disconnect the finger connectors of the fan (NB: the work does not require an electrician)
- » Pull the fans out of their mounting rail
- » Clean the fan with a soft brush and a vacuum cleaner. NB: the fan blades have balancing strips which must not be removed.
- » Slide the fan back onto the mounting rail, attach the finger connectors, reinstall the flashing and the cell strips
- » Reinstall the heat recovery cell and close the lid

## Cleaning the duct system

Residential area and location have a significant impact on the cleaning intervals of duct systems. It is recommended that mechanical air handling systems be cleaned every 5–10 years. Remove the fans from the unit in order to clean it. If necessary, the post heater element can also be removed.

## Condensation water

The condensate drainage from the unit must be checked annually. Pour water into the bottom of the unit and check that the water flows well through the condensation drain. If you hear a pulsating sound from the drain, the water seal may be dry. In this case, pour water on the bottom of the unit.

## Airfi water seal

The water seal can be opened from above and below for cleaning. This way you can clean the drip pot and condensate ball. After cleaning, pour water on the bottom of the unit to make sure the water seal works.

## Other maintenance

Cleaning the inside of the unit by vacuuming or wiping with a damp cloth as necessary

# Technical specifications



**Model**  
**60**



**Model**  
**100**



**Model**  
**130**

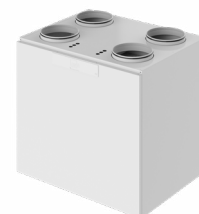

**Model**  
**150**

Dimensions (width x height x depth)	558 x 450 x 558	558 x 490 x 558	558 x 490 x 558	700 x 850 x 645
Weight	44 kg	46 kg	46 kg	77 kg
Duct outlets	4x160, 1x125	4x160, 1x125	4x160, 1x125	4x200
Kitchen bypass	●	●	●	-
Condensate fitting	Centre, 66 mm from rear edge	Centre, 66 mm from rear edge	Centre, 66 mm from rear edge	Centre, 110 mm from rear edge
Condensation water tray	Tilted condensation water tray	Tilted condensation water tray	Tilted condensation water tray	Tilted condensation water tray
Max. extract air flow rate (100 Pa)	107 dm <sup>3</sup> /s	107 dm <sup>3</sup> /s	142 dm <sup>3</sup> /s	180 dm <sup>3</sup> /s
Max. supply air flow (100 Pa)	99 dm <sup>3</sup> /s	95 dm <sup>3</sup> /s	125 dm <sup>3</sup> /s	159 dm <sup>3</sup> /s
Specific energy consumption (SEC) in a cold climate	A+	A+	A+	A+
Specific energy consumption (SEC) in an average climate	A	A	A	A
Extract air heat recovery annual efficiency class	A+/A (kitchen bypass in use)	A+/A (kitchen bypass in use)	A+/A (kitchen bypass in use)	A+
Air handling unit's specific electrical power class at rated air flow	A	A	A	A
Electric	230 V, 50 Hz, 10 A, max. 1165 W: Plug	230 V, 50 Hz, 10 A, max. 1165 W: Plug	230 V, 50 Hz, 10 A, max. 1255 W: Plug	230 V, 50 Hz, 16 A, max. 2200 W: Plug
<b>Summer/winter function</b>				
Automatic, regulating	●	●	●	●
<b>Defrosting automation</b>				
Continuous supply air, AFPS	●	●	●	●
<b>Post heater</b>				
	920 W (electric)	920 W (electric)	920 W (electric)	2 x 920 W (electric)
<b>Equipment</b>				
Ceiling mount bracket	●	●	●	-
Wall mount bracket	●	●	●	●
Stand	-	-	-	●
Vapour barrier sealing plate	●	●	●	●
Humidity transmitter (internal)	●	●	●	●
Humidity transmitter	●	●	●	●
Carbon-dioxide transmitter	●	●	●	●
Cooling radiators	●	●	●	●
Filter guard	●	●	●	●
Constant pressure control	●	●	●	●
Spring return damper	●	●	●	●
Airfi KNX adapter	●	●	●	●
<b>Controls</b>				
Uno, Sento, Mille-Wire, Mille-Wifi	●	●	●	●
Control hoods	●	●	●	●
Control-command centre, DDC, 10 V DC, Transmitter controls Modbus RTU/TCP, Ethernet	●	●	●	●

● Standard equipment

● Accessories

# Dimensional drawings



**Model 60**

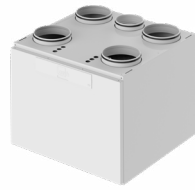

**Model 100 Model 130**

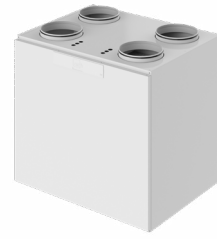

**Model 150**

Front

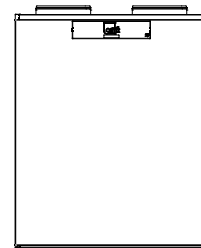
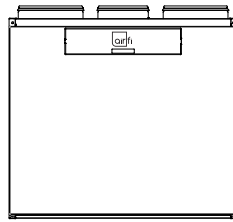
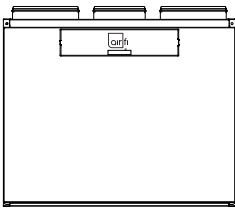

Side

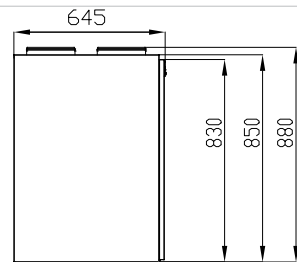
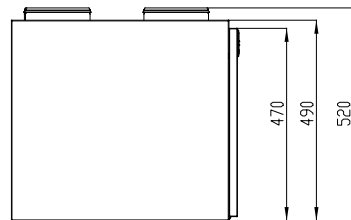
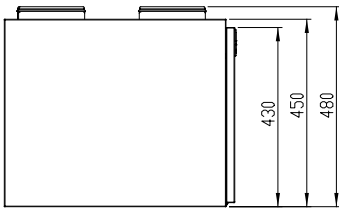

Model R

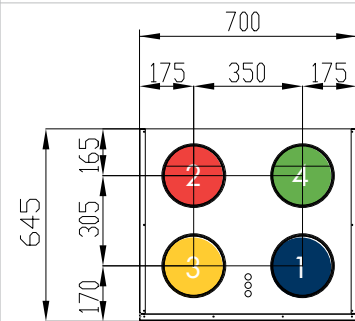
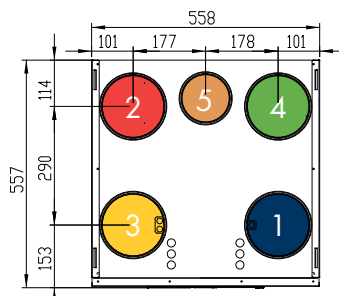
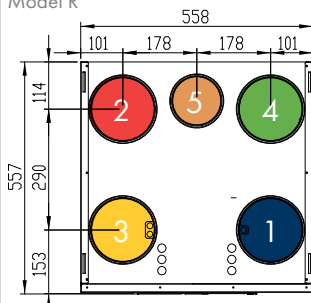

Model L

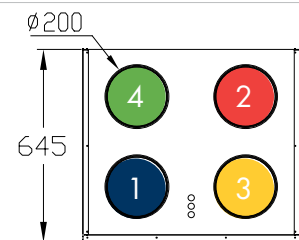
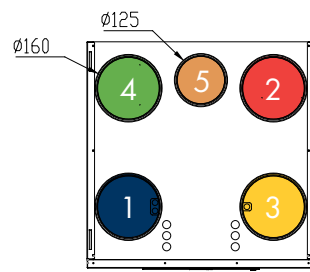
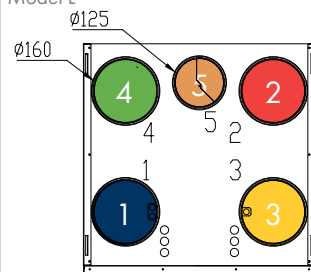

Below

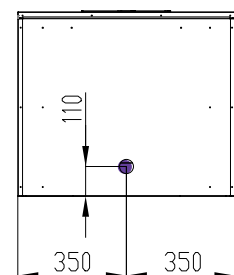
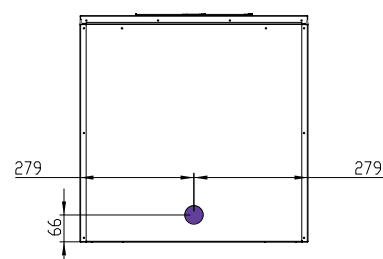
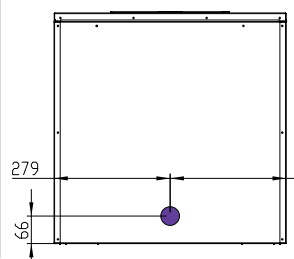

- Outdoor air (1)
- Supply air (2)
- Extract air (3)
- Exhaust air (4)
- Kitchen bypass (5)
- Condensate outlet (6)

# Air flow

The Airfi calculation programme calculates accurate octave-band sound power levels of the air flow in the duct system and the environment. The programme also calculates the control percentages for both fans and the SFP value according to the given air flow and duct pressure drop. The programme also shows the unit's annual efficiency. This document can also be used as an appendix to an application for a building licence.

## Model 60

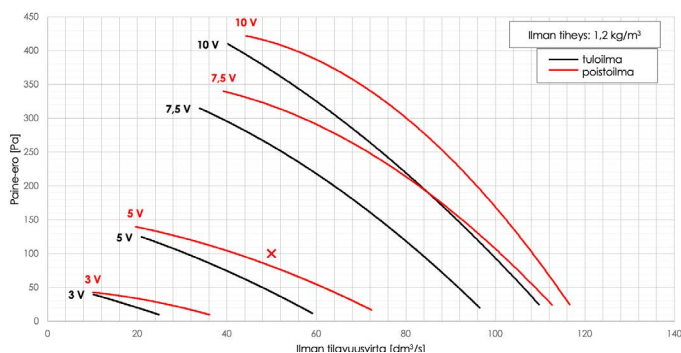

## Model 100

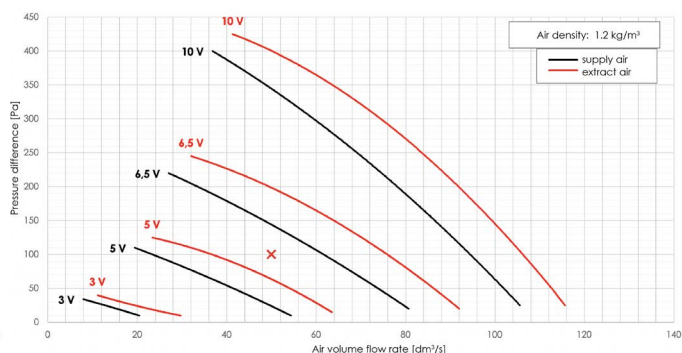

## Model 130

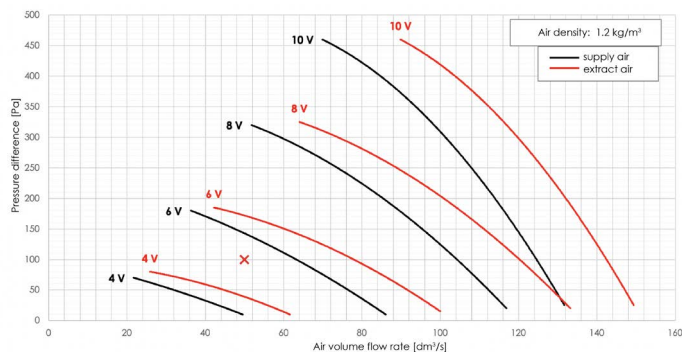



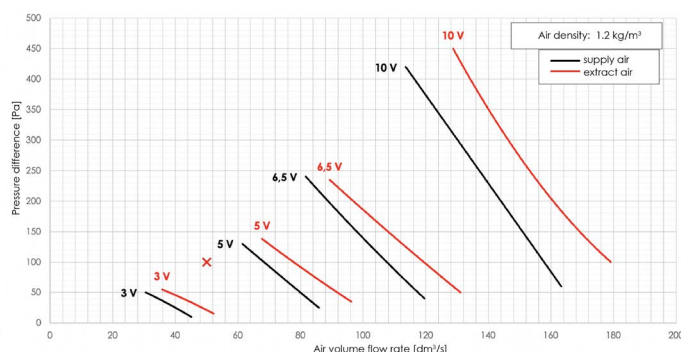

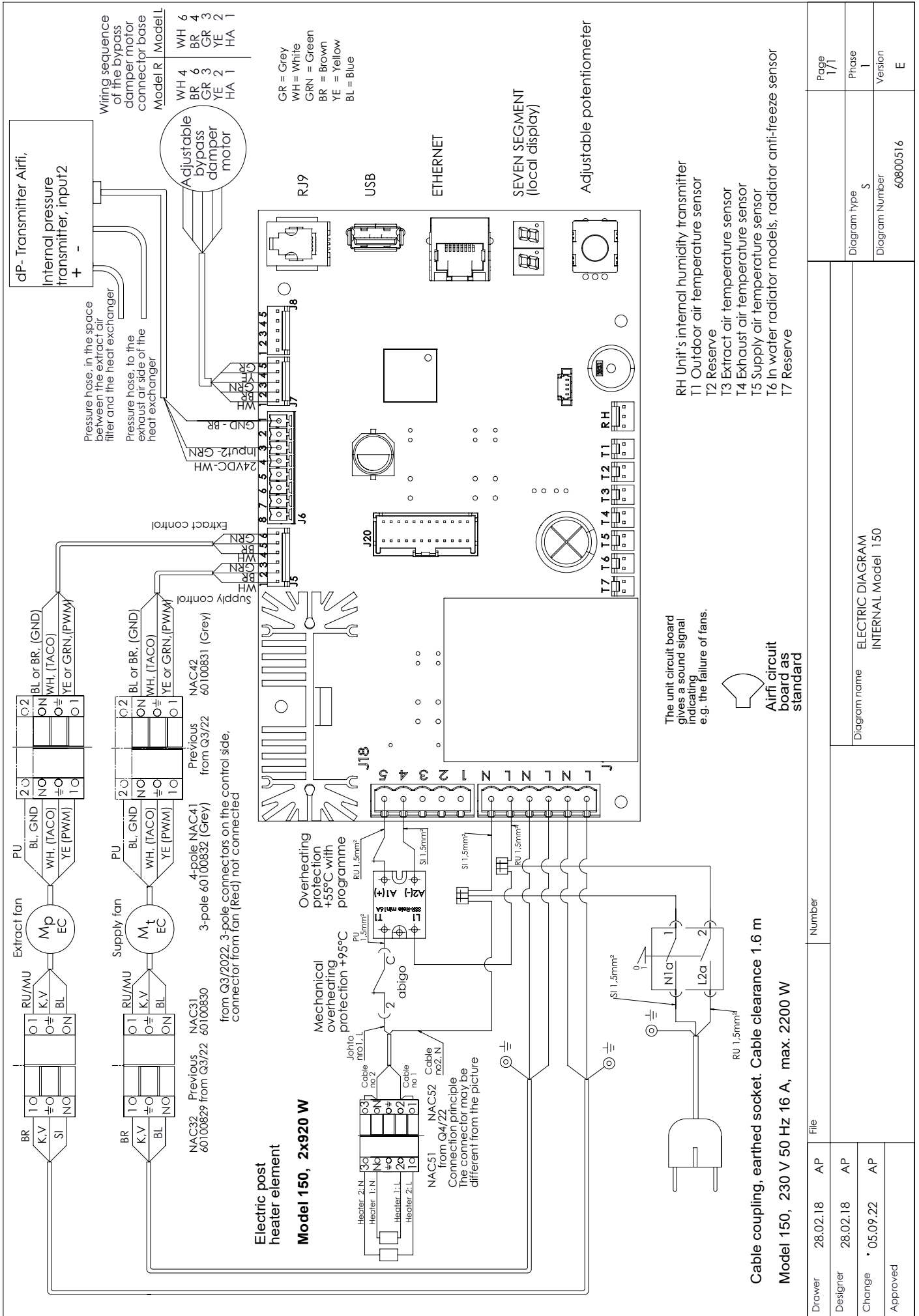

## Model 150

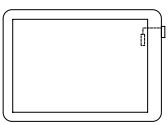
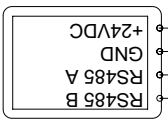
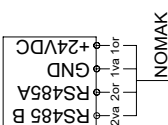
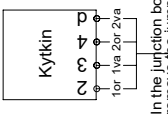
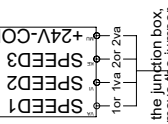
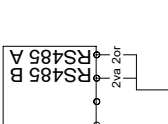
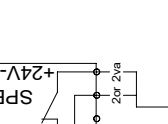
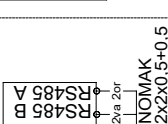
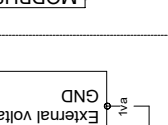

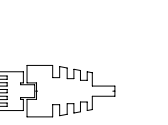
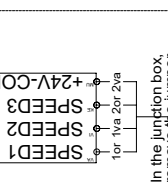
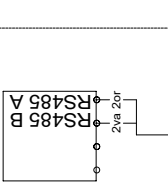
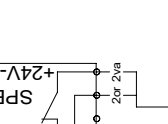
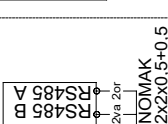
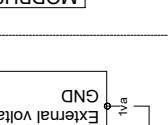

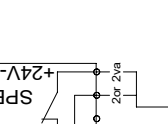
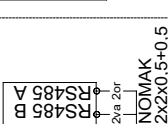
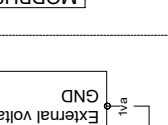

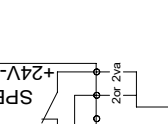
<p><b>Airfi Mille-Wifi Controller</b> LVI No 7916040 Airfi: 40 000 042</p>  <p>NB: Connect the unit's Ethernet cable to the internet Wi-Fi switch in the controlled space</p> <p>In the junction box, leave the jumper wire between Speed1...+24-COM</p> <p>Mille-Wifi power supply: 1.0-couplet (SU), recommended installation height 1.6 m</p>	<p><b>Airfi Mille-Wire Controller</b> LVI No 7916065 Airfi: 40 000 052</p>  <p>In the junction box, wiring sequence according to the print on the box</p> <p>In the junction box, leave the jumper wire between Speed1...+24-COM</p> <p>Mille-Wire, hard-wired 1.0-couplet (SU), recommended installation height 1.6 m</p> <p>DIP 1: RS485 Termination ON/OFF 2: RS485 Termination ON/OFF 3: Freplace button ON/OFF 4: -</p>	<p><b>Airfi Sento Controller</b> LVI No 7916039 Airfi: 40 000 041</p>  <p>In the junction box, wiring sequence according to the print on the box</p> <p>In the junction box, leave the jumper wire between Speed1...+24-COM</p> <p>Sento, hard-wired 1.0-couplet (SU), recommended installation height 1.6 m</p>	<p><b>Airfi Uno Switch - 5-speed</b> LVI No 7916038 Airfi: 40 000 040</p>  <p>In the junction box, remove the jumper wire between Speed1...+24-COM</p> <p>Mechanical control hoods: Speed control / Vacuum compensation / Automatic boost, when cooking (minimum speed adjustable)</p>	<p><b>Airfi Pia Control Hood 1-5 speeds</b></p>  <p>In the junction box, wiring sequence according to the print on the box</p> <p>Electronic control hoods: Speed control / Vacuum compensation / Automatic boost, when cooking (minimum speed adjustable)</p>	<p><b>Airfi Suvi Airfi Ida Airfi Eva Booster Hood Control Hood</b></p>  <p>In the junction box, wiring sequence according to the print on the box</p> <p>NB: The jumper wire in the junction box is connected between Speed3...+24-COM</p> <p>Mechanical booster hoods: The unit is always set at speed 3, opening the booster valve; Vacuum compensation / Automatic boost when cooking (minimum speed adjustable)</p>	<p><b>Airfi Pia Booster Hood</b></p>  <p>In the junction box, wiring sequence according to the print on the box</p> <p>NB: The jumper wire in the junction box is connected between Speed3...+24-COM</p> <p>Electronic booster hoods: The unit is always set at speed 3, opening the booster valve; Vacuum compensation / Automatic boost when cooking (minimum speed adjustable)</p>	<p><b>Airfi Suvi Airfi Ida Airfi Eva Booster Hood</b></p>  <p>In the junction box, wiring sequence according to the print on the box</p> <p>NB: The jumper wire in the junction box is connected between Speed3...+24-COM</p> <p>Electronic booster hoods: The unit is always set at speed 3, opening the booster valve; Vacuum compensation / Automatic boost when cooking (minimum speed adjustable)</p>	<p><b>Ventilation Emergency Stop</b></p>  <p>The ventilation emergency stop circuit is opto-isolated (external 24VDC)</p> <p>If desired, voltage can be applied to the circuit from the connection board: When voltage is applied to the circuit, the unit will stop (NB: will destroy the circuit board). See wiring diagram 60.000.754</p>	<p><b>ModBus RTU</b></p>  <p>JAMAK 2x(2+1)x0.5+0.5 Incoming Outgoing MODBUS</p>	<p><b>ModBus TCP</b></p>  <p>Ethernet cable CAT5E/CAT6/CAT7 Ethernet cable wired outside the unit, clearance 1.6 m MODBUS</p>			
<p><b>VAK</b> 0-10 V control available for direct control and two-speed operation</p> <p>Unit control with 0-10 V signal</p>  <p>Separate control after-heating 0-10 V extract fans</p>  <p>Supply fan isolation from circuit board/control panel or Modbus</p> <p>Extract fan 0-10 V Supply fan 0-10 V control message</p> <p>The temperature setpoint is indicated in the control message</p>	<p><b>Pressure balancing</b></p>  <p>Voltage-free status signal Fireplace/Cooker hood/ AUX 1 / PRESS COMP. / AUX 2 / OUTD. VALVE</p>	<p><b>Control of the outdoor air damper relay</b></p>  <p>24VDC relay AUX 3 / RH input</p>	<p><b>Humidity switch (RH)</b></p>  <p>Humper connection in the switch +24VDC.COM AUX 3 / RH input</p>	<p><b>Humidity transmitter (RH)</b></p>  <p>Humper connection in the switch +24VDC.COM AUX 3 / RH input</p>	<p><b>Carbon-dioxide switch (CO2)</b></p>  <p>Humper connection in the switch +24VDC.COM AUX 4 / CO2 input</p>	<p><b>Carbon-dioxide transmitter (CO2)</b></p>  <p>Humper connection in the switch +24VDC.COM AUX 4 / CO2 input</p>	<p><b>Airfi Service / Airfi Cloud</b></p>  <p>Internet Wi-Fi switch</p> <p>Ethernet cable CAT5E/CAT6/CAT7 Ethernet cable wired outside the unit, clearance 1.6 m</p>	<p><b>Unit supply</b></p>  <p>Cable coupling, earthed socket. Cable clearance 1.6 m Model 60, 230 V 50 Hz 10 A, max. 1165 W Model 100, 230 V 50 Hz 10 A, max. 1165 W Model 130, 230 V 50 Hz 10 A, max. 1255 W Model 150, 230 V 50 Hz 16 A, max. 2200 W</p>	<p><b>Exhaust hood supply</b></p>  <p>Cable coupling 230 V 50 Hz 10 A Earthed socket Cable clearance 1.6 m</p>	<p><b>ALL THESE AS STANDARD (without accessories)</b></p> <p>Designer 28.02.18 AP Change 29.04.2021 AP</p>	<p>Diagram name ELECTRIC DIAGRAM EXTERNAL, Model 60, Model 100, Model 130, Model 150 Connection points in the external terminal box and cable coupling</p>	<p>Diagram type S Diagram Number 60800063</p>	<p>Page 1/1 Version Q</p>

# Potentiometric setup – Seven-segment



**NB:**

The potentiometer is active after 30s from the moment the unit is powered on.

## Setting the supply air temperature.

Start: 7-segment display shows no signs

1. Press the potentiometer once to display the temperature at which the supply air is set
2. Turn the potentiometer clockwise or counter clockwise to the desired temperature
3. Press the potentiometer again to save the value.
4. The programme moves on to the setup menu. Wait a moment until the automatic exit from the setup mode.
5. The supply air temperature can also be found in C1.

<b>A</b>	Adjusting the extract fan speeds
<b>B</b>	Adjusting the supply fan speed
<b>C</b>	Post heater
<b>D</b>	Settings for controls
<b>E</b>	Error
<b>F</b>	Heat recovery bypass
<b>H</b>	Hoarfrost protection
<b>U</b>	Modbus
<b>J</b>	Sauna
<b>N</b>	Cooker hood / fireplace / central vacuum cleaner overpressure function / sauna
<b>U</b>	Modbus
<b>P</b>	Boost settings
<b>Y</b>	Settings
<b>&lt;&lt;</b>	Back, return

<b>A</b> Adjusting the extract fan speeds			
A1	Extract fan speed 1	range 25...99, factory setting 30	NB: The speed 5 control is also the maximum voltage of the unit (the unit cannot run at a value higher than the specified value)
A2	Extract fan speed 2	range 25...99, factory setting 40	
A3	Extract fan speed 3	range 25...99, factory setting 55	
A4	Extract fan speed 4	range 25...99, factory setting 75	
A5	Extract fan speed 5,	range 25...99, factory setting 99.	
<b>B</b> Adjusting the supply fan speed			
B1	Supply fan speed 1	range 25...99, factory setting 30	
B2	Supply fan speed 2	range 25...99, factory setting 40	
B3	Supply fan speed 3	range 25...99, factory setting 55	
B4	Supply fan speed 4	range 25...99, factory setting 75	
B5	Supply fan speed 5	range 25...99, factory setting 99	
<b>C</b> Post heater settings			
C1	Desired supply air temperature (default window)	range 0...12–26°C, factory setting +17°C	Temperature set point (same set point for heating/cooling)
C2	Resistor connection temperature	range 0...+8°C, factory setting +8°C	when the outdoor air temperature T1 is higher than the set temperature, the resistor is not switched on
C3	Temperature set point in "away" mode	range 5–26°C, factory setting +17°C	
<b>D</b> Settings for controls			
D1	Joint adjustment	ON/OFF, default OFF = 0 = not selected	
D2	Joint adjustment control value	-99...+99	Joint adjustment control of the supply fan in relation to the extract fan, same adjustment at all speeds
D3	Compensation or stop, junction box pins 1,2,3	0, 1 Factory setting 1	1 = selected for exhaust hood compensation, 0 = selected to stop the unit when the contacts open, factory setting 1
D4	If D3 exhaust hood compensation is selected, the speed of the supply fan relative to the extract fan in the compensation situation	-99...+99 (factory setting 0)	
D5	Selected minimum speed when opening the exhaust hood booster valve	speed 3–5 (factory setting 4)	
D6	Control speed = to which position the required air flow is set	1–5 (factory setting 3)	
D7	Operating principle of the AUX2/OUTD. VALVE connector	0 = outdoor air damper relay control (factory setting) 1 = solution radiator, location in supply air duct (cooling) 2 = solution radiator, location in outdoor air duct (pre-heating/cooling)	
D8	Cooling mode temperature limit (T1 monitoring if D7 = 1)	10–25°C (factory setting +17°C)	
D9	Pre-heating temperature limit (D7 = 2)	-6...-2°C, default -4°C	
<b>E</b> Error info			
E0	General alert		More information in the app or on the Mille controller
E1	External shutdown of all unit fans, MODBUS or Ethernet command		
E2	Bypass damper malfunction		Check the operation of the bypass damper
E3	Supply fan not running		Fan controls or fan defective
E4	Extract fan not running		Fan controls or fan defective
E5	Radiator anti-freeze		Only in water models, will be removed when the conditions for starting the unit are met again



E6	Sensor error		Flashing E6 and the sensor that is broken
E7	Hoarfrost protection pressure transmitter broken		
E8	Supply and extract fan temperatures incorrect		Check the handedness of the unit
E9	Constant pressure control alarm		
<b>F</b>	<b>Heat recovery bypass</b>		
F1	Bypass setting temperature	range +15....+30°C (factory setting +22°C)	
F2	Permissible lower limit for outdoor air bypass	range 5....30°C, default +9°C	
F3	Bypass delay	range 5....20 min, setting 5 min	
F4	Minimum supply air setting	range +13.... +26°C (factory setting +14°C)	
<b>H</b>	<b>Hoarfrost protection</b>		
H1	Selected hoarfrost protection programme	1	default 1 – Airfi Pro Frost System
H2	Hoarfrost protection level (sensitivity)	0....10 (factory setting 5, neutral)	In range 6–10, the hoarfrost protection is more active than in the neutral level.
H3	<i>Not in use, reserve</i>		
H4	Forced defrost	The function performs a 30-minute forced defrost, after which it automatically returns to normal mode	
<b>I</b>	<b>Other settings</b>		
I1	Fire risk alarm, extract	0–99°C, 0 = off	default 70°C
I2	Fire risk alarm, supply	0–99°C, 0 = off	default 50 °C
<b>U</b>	<b>Modbus</b>		
U1	Modbus ID	1–99 (controller - 1-253) - constant 1)	
U2	Modbus traffic speed	9600,19200,38400,57600,115200	11,22,33,44,55 (flashing)
U3	<i>Not in use, reserve</i>		
U4	Modbus bus parity	0, 1, 2	0=None (constant), 1=Odd, 2=Even
U5	Modbus bus stop bits	1.2	1 (constant), 2
<b>N</b>	<b>Cooker hood / fireplace / central vacuum cleaner overpressure function / sauna / maintenance</b>		
N1	Overpressure function time	0....30 min, factory setting 15 min	e.g. fireplace (impulse function)
N2	Overpressure function delay	0....30 min, factory setting 0 min	e.g. fireplace (delay when the contact opens)
N3	Overpressure function supply fan speed	0...99%, factory setting 70	e.g. fireplace
N4	Overpressure function extract fan speed	0...99%, factory setting 35	e.g. fireplace
N5	Sauna function activity time (prevents the humidity transmitter from boosting for the specified time)	0.5 h, 1.0 h, 1.5 h, 2.0 h 2.5 h, 3.0 h, 3.5 h, 4.0 h	The time when the internal humidity transmitter does not automatically increase ventilation when humidity rises. When the time ends, the boost function starts automatically.
N6	Service reminder interval	0–6 times a year. Default 0	E.g. filter replacement
<b>P</b>	<b>Boost settings</b>		
P1	Panel booster function (Mille/Sento)	0...100%, factory setting 30%	Boosts the existing speed by the specified percentage, time set from the panel
P2	Boosted cooling allowed/not allowed	0 = Not allowed (factory setting), 1 = Allowed (user activation permission required to enable the function)	
P3	Control factor for boosted cooling	10–100% (factory setting 15%)	(more fan power if the desired temperature is not reached)
P4	Operation of the internal humidity transmitter	Fan function when humidity rises: 0 = Switch function / 1 = Transmitter function (default) / 2 = Disabled	
P5	Setpoint for internal humidity transmitter	50....90%, factory setting 70%	
P6	Boost rate of the internal humidity transmitter if switch function selected	30....100, factory setting 60%	
P7	Average temperature of the daily TI measurement at which the humidity transmitter must not boost	+15...+22 (factory setting +20 degrees)	
P8	Control factor in humidity transmission	10–100% (factory setting 15%)	
P9	Humidity transmission anomaly	1–5 % (factory setting 5 %)	
<b>Y</b>	<b>Settings</b>		
Y1	Factory setting reset	-> Step 1, still requesting Y or N	Restores factory settings (fan settings and Modbus parameters are not changed)
Y2	Backup card -> USB		
Y3	Restore USB -> card	-> Step 1, still requesting Y or N	
Y4	Save the log to USB		
Y5	Software version	Displays the display version	
Y6	TRIAC test	Triac operation test	
Y7	Ethernet connection active	1 = Connected / 0 = No connection	Displays the status of the Ethernet connection.
Y8	Activate remote logging	0 = Off / 1 = On	Requires an Ethernet connection.
Y9	Fixed IP address reset	DHCP is activated again	

## Other functions

<b>Ventilation emergency stop - and + function</b>	<p>When a command comes in, stops the fans = control value for fan 0, regardless of what else the controllers request</p> <p><b>NB:</b> When the circuit is open, the unit runs normally. If 24 V DC is applied to the circuit, the unit will stop.</p>
<b>Status out - gnd function</b>	<p>Gives out the speed of the unit as a voltage signal</p> <p><b>Dual-speed operation</b> 0 = unit stopped Speed 1 (connected circuit closed between Speed1-24V-com) output voltage 1.0 V Speed 2 (connected circuit closed between Speed2-24V-com) output voltage 2.0 V</p> <p><b>0–10 V direct control, threshold voltage 2.5 V = 25% then fans are allowed to start</b> 0 = unit stopped (between SPEED1-GND, voltage value 0.0 V–2.49 V)</p> <p>0–10 V direct control, stepless between 2.5 V = 25% ..</p> <p>10 V = 100 %, gives out a value corresponding to the fan speed 2.5...10 V</p> <p>E.g. between SPEED1-GND is passed 50%=5.0 V control command-&gt; equivalent is fed out of this 50% = 5.0 V</p>

Raisio

01.09.2018

## DECLARATION OF CONFORMITY

We declare that Airfi Oy's Model air handling units and exhaust hoods comply with the following EC Directives:

Machinery Directive (2006/42/EC)  
Low Voltage Directive (2006/95/EC)  
EMC Directive (2014/108/EC)

and that the following harmonised standards have been applied:

SFS-EN ISO 12100 Machine safety  
SFS-EN 55014-1 Electromagnetic emissions  
EN 61000-3-2 Electromagnetic interference  
SFS-EN 60335-1 Household appliances

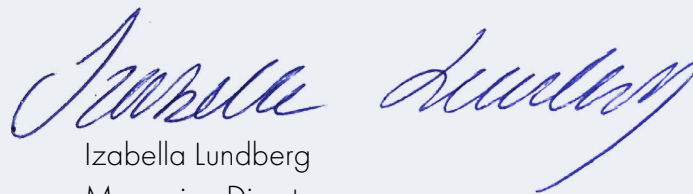

Izabella Lundberg  
Managing Director  
Airfi Oy AB

-We reserve the right to make changes-



**Airfi Oy AB**  
Piilipuunkatu 11  
21200 Raisio, Finland

+358 (0)2 430 3300  
[www.airfi.fi](http://www.airfi.fi)  
[info@airfi.fi](mailto:info@airfi.fi)

REV A2-2022  
60800377